

MEMBRANE KEY PAD
Recessed Area Size

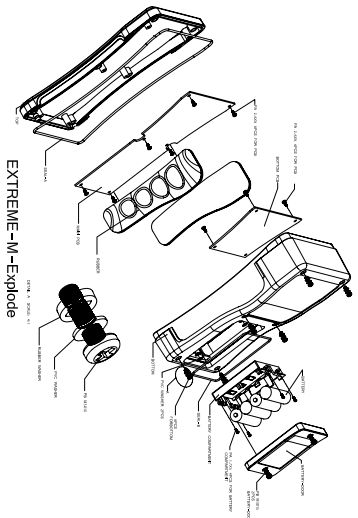
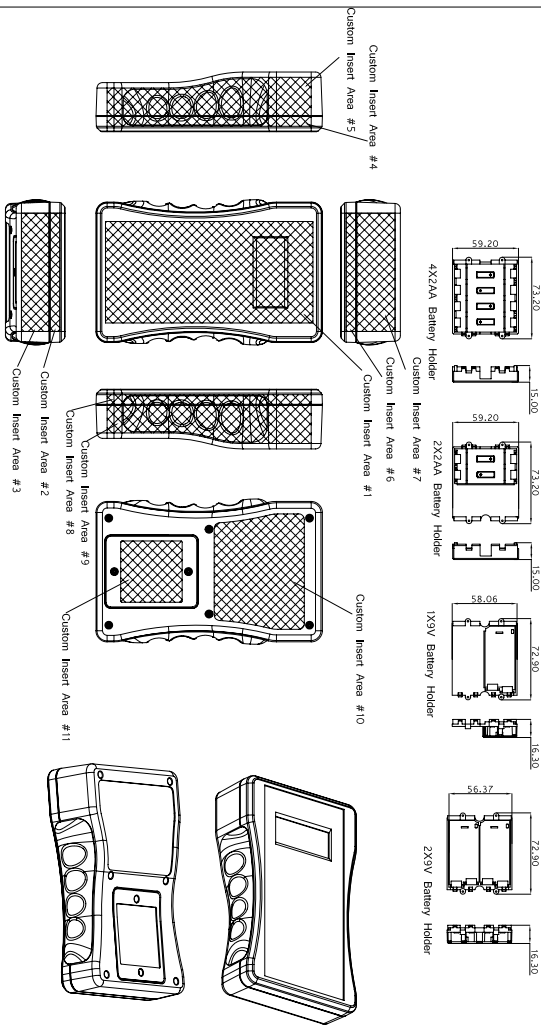
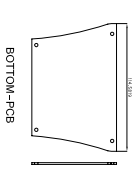
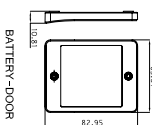
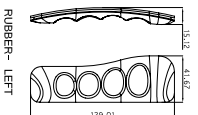
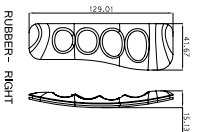
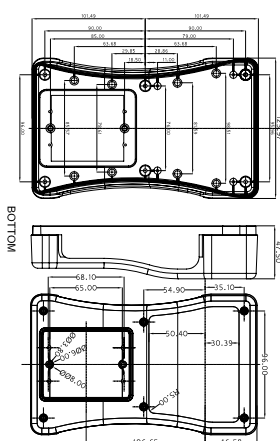
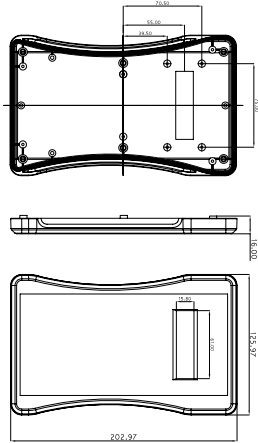

Part #	Color	LCD	LCD Type	LCD Part #	LCD
320-12-BK	Black	None	None	None	None
321-12-BK	Black	24X10	None	MDL(S)-16265	Vortronix
322-12-BK	Black	24X10	16x2 compact	MDL(S)-16255B	Vortronix
323-12-BK	Black	24X10	16x4	MDL(S)-16465	Vortronix
320-12-TV	White	None	None	None	None
321-12-TV	White	24X10	16x2	MDL(S)-16265	Vortronix
322-12-TV	White	24X10	16x2 compact	MDL(S)-16255B	Vortronix
323-12-TV	White	24X10	16x4	MDL(S)-16465	Vortronix

Part #	Battery Type	Color	300 Series - Medium Enclosures	300 Series - Rubber Side Grips
SBH-2-9V-BK	For 2 9V batteries	Black	320-9B	Black
SBH-2-9V-TV	For 2 9V batteries	White	320-9R	Green
SBH-2-AA-BK	For 2 AA batteries	Black	320-5T	Grey
SBH-2-AA-TV	For 2 AA batteries	White	320-5B	Light Blue
SBH-4-AA-BK	For 4 AA batteries	Black	320-9R	Orange
SBH-4-AA-TV	For 4 AA batteries	White	320-9U	Off White
SBH-9V-BK	For 1 9V batteries	Black	320-9D	Red
SBH-9V-TV	For 1 9V batteries	White	320-9E	Yellow

THIS DRAWING IS THE PROPERTY OF AND MAY EMPLOY PROPRIETARY INFORMATION OWNED BY BOX ENCLOSURES. IT IS PROVIDED UNDER A CONFIDENTIAL RELATIONSHIP FOR A SPECIFIC PURPOSE. THE RECIPIENT AGREES TO USE IT ONLY FOR SUCH PURPOSE AND RETURN IT TO BOX ENCLOSURES UPON REQUEST.

ENCLOSURES & ASSEMBLY SERVICES

Title
300 Series-Medium Grip Tech Master Drawing

Material:
Polycarbonate

Sealing Rating:
NEMA 4/IP65

Burn Rating:
UL 94 V2

TOLERANCE
all dimension in mm
unless otherwise specified

±0.20
±0.10
±0.05
ANGLE ±0.5°

Revisions:
Rev 2

Date: 2008-09-29

Rohs Compliant