

BOTTOM-INSIDE

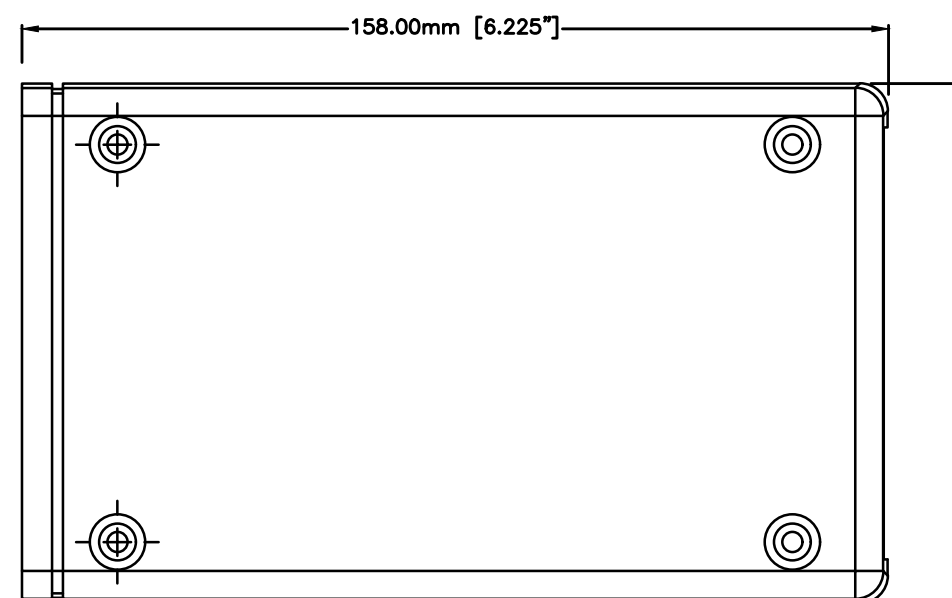

BOTTOM-OUTSIDE

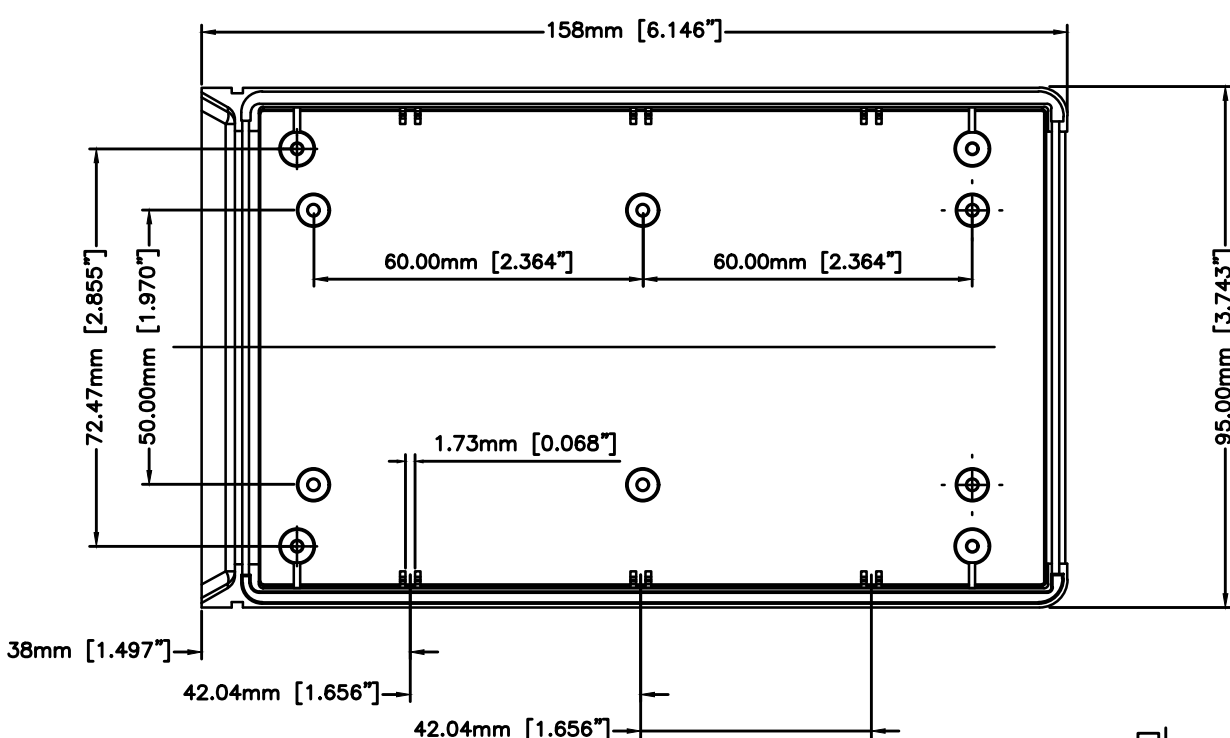

TOP-INSIDE

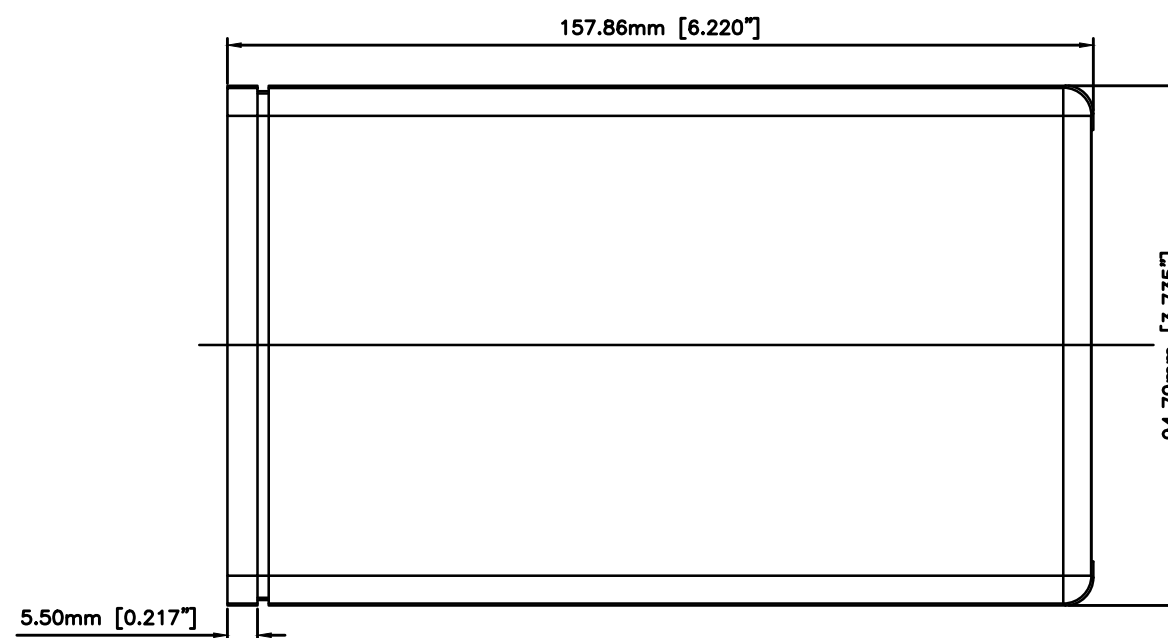

TOP-OUTSIDE

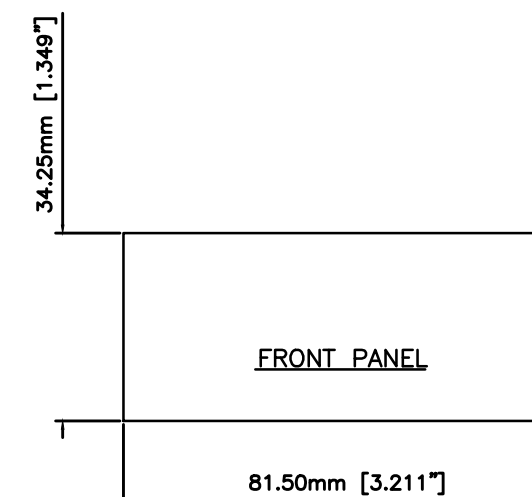

FRONT PANEL

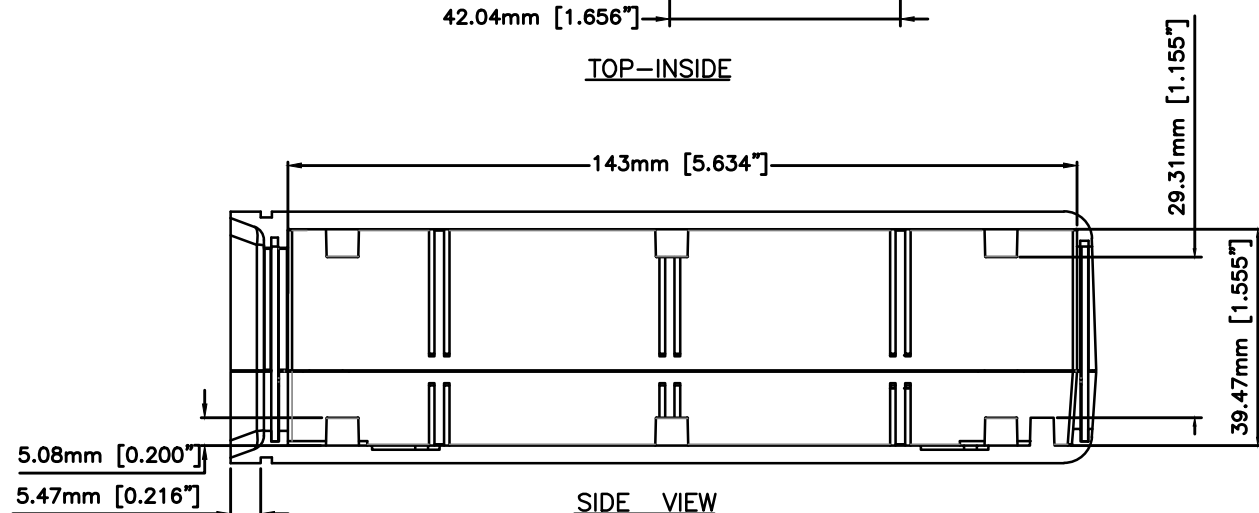

SIDE VIEW



FRONT END VIEW

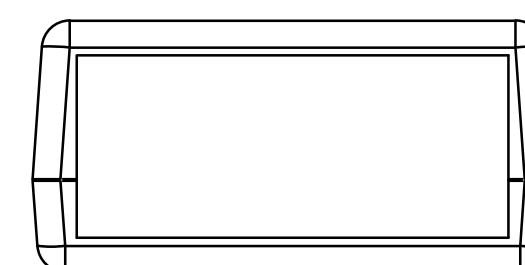

BACK END VIEW

Max. PCB size: Bottom 85 x 113mm, Top 85 x 142mm
 (Cutout of pillars not taken into consideration)

THIS DRAWING IS THE PROPERTY OF AND MAY EMBODY PROPRIETARY INFORMATION OWNED BY Box Enclosures® IT IS PROVIDED UNDER A CONFIDENTIAL RELATIONSHIP FOR A SPECIFIC PURPOSE. THE RECIPIENT AGREES TO USE IT ONLY FOR SUCH PURPOSE AND RETURN IT TO Box Enclosures® UPON REQUEST.

Title Eng. Drawing C size Master

DATE 1/19/2020 BOX # UOOM-120-MASTER Drn. by R.F.K.

SCALE 1:1 SHEET 1 of 1 REV 19.A