

BOTTOM - INSIDE

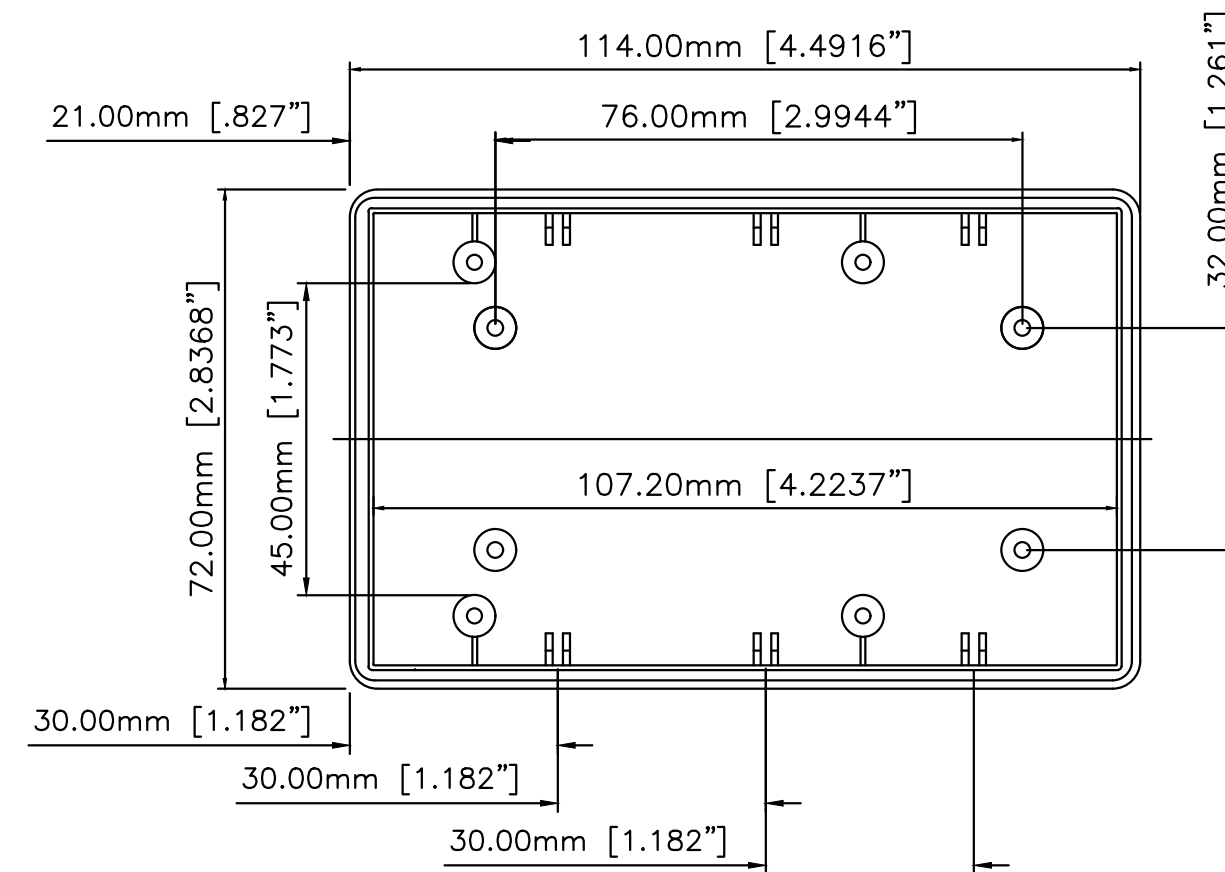

TOP - INSIDE

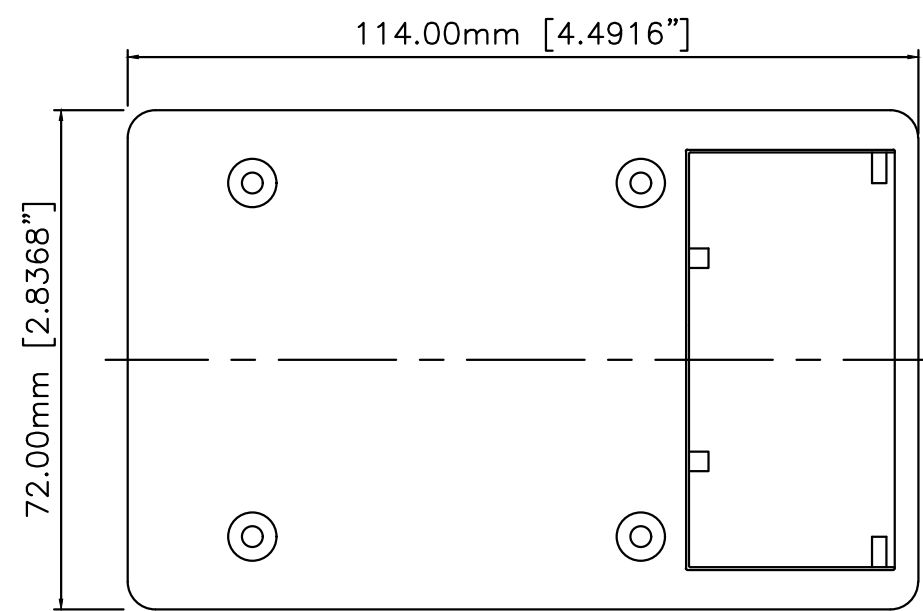

BOTTOM - OUTSIDE

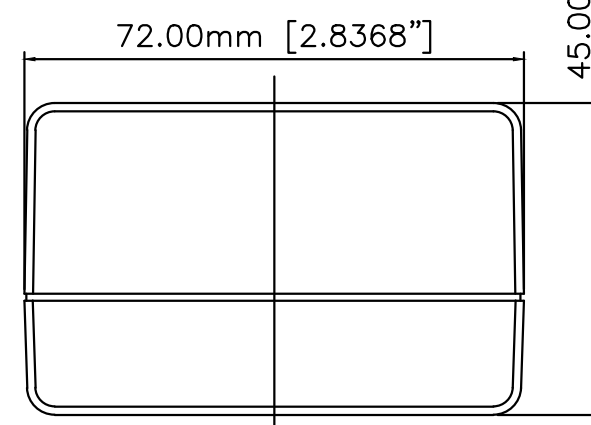
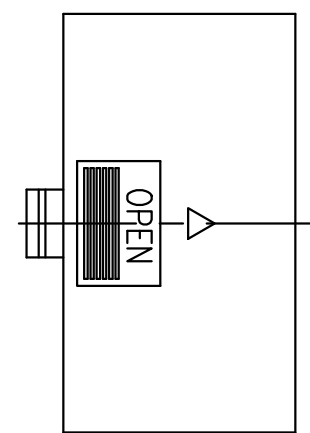

END VIEW

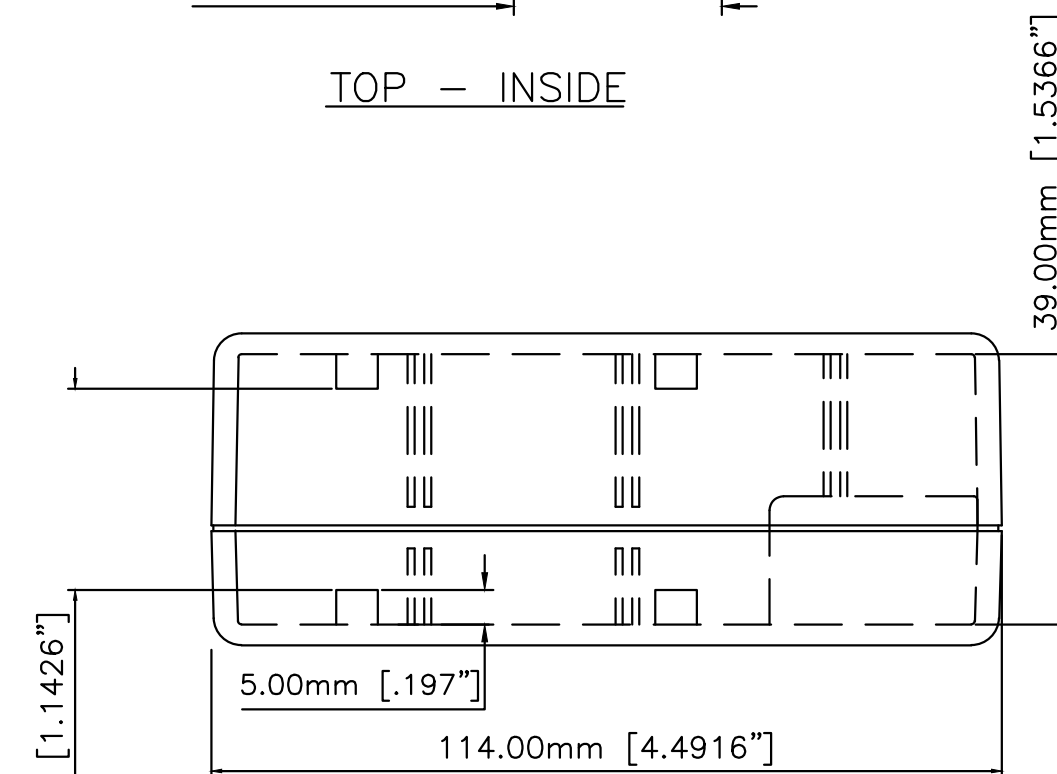

SIDE VIEW

Title Eng. Drawing C size Master

DATE 3/9/19 BOX # UCCS-122-MASTER Drn. by R.F.K.

SCALE 1:1 SHEET 1 of 1 REV 19.A

THIS DRAWING IS THE PROPERTY OF AND MAY EMBODY PROPRIETARY INFORMATION OWNED BY Box Enclosures® IT IS PROVIDED UNDER A CONFIDENTIAL RELATIONSHIP FOR A SPECIFIC PURPOSE. THE RECIPIENT AGREES TO USE IT ONLY FOR SUCH PURPOSE AND RETURN IT TO Box Enclosures® UPON REQUEST.