

BOTTOM-INSIDE

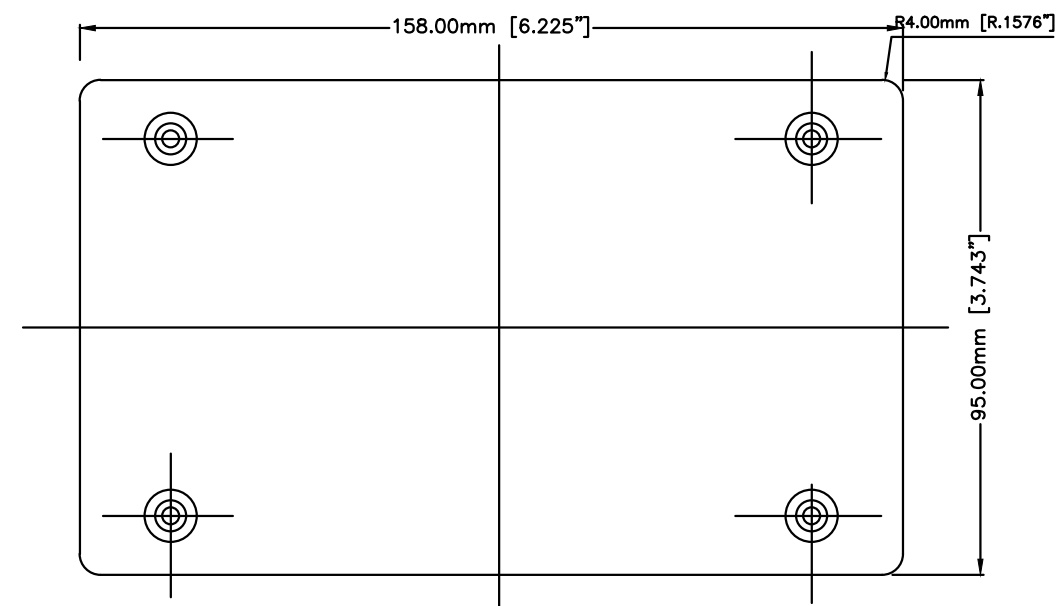

BOTTOM-OUTSIDE

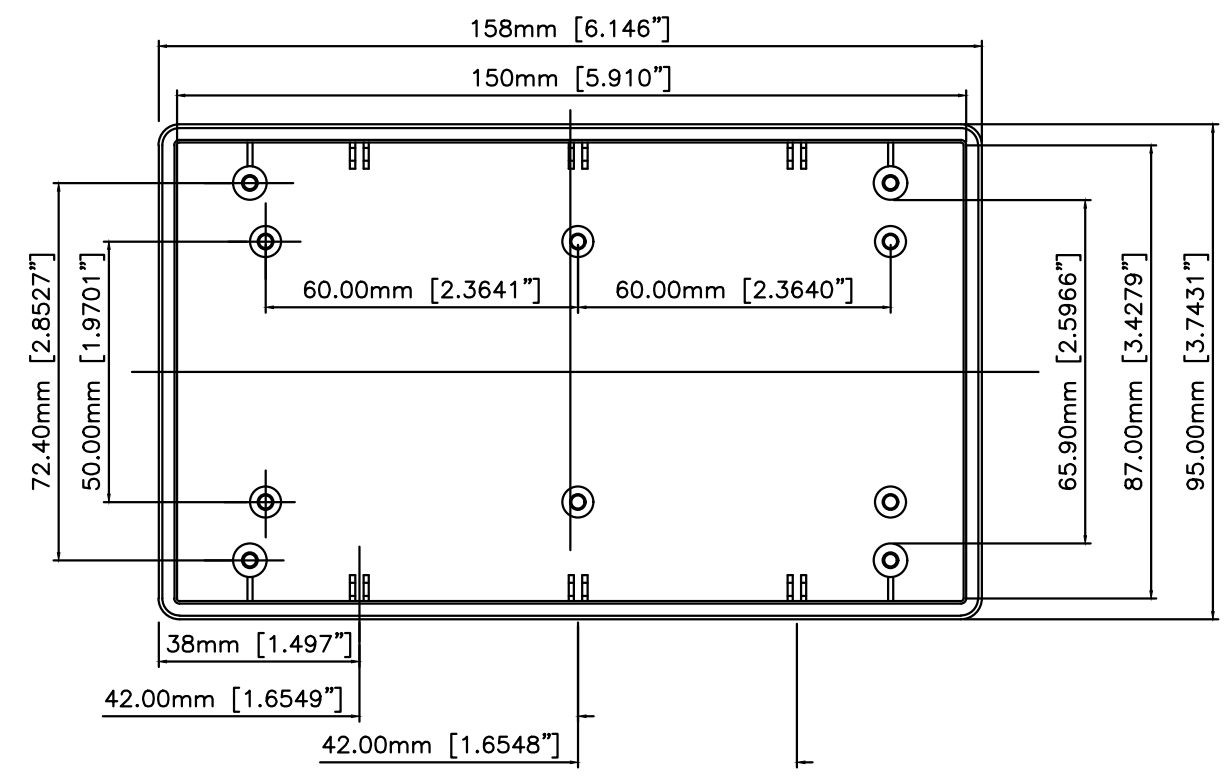

TOP-INSIDE

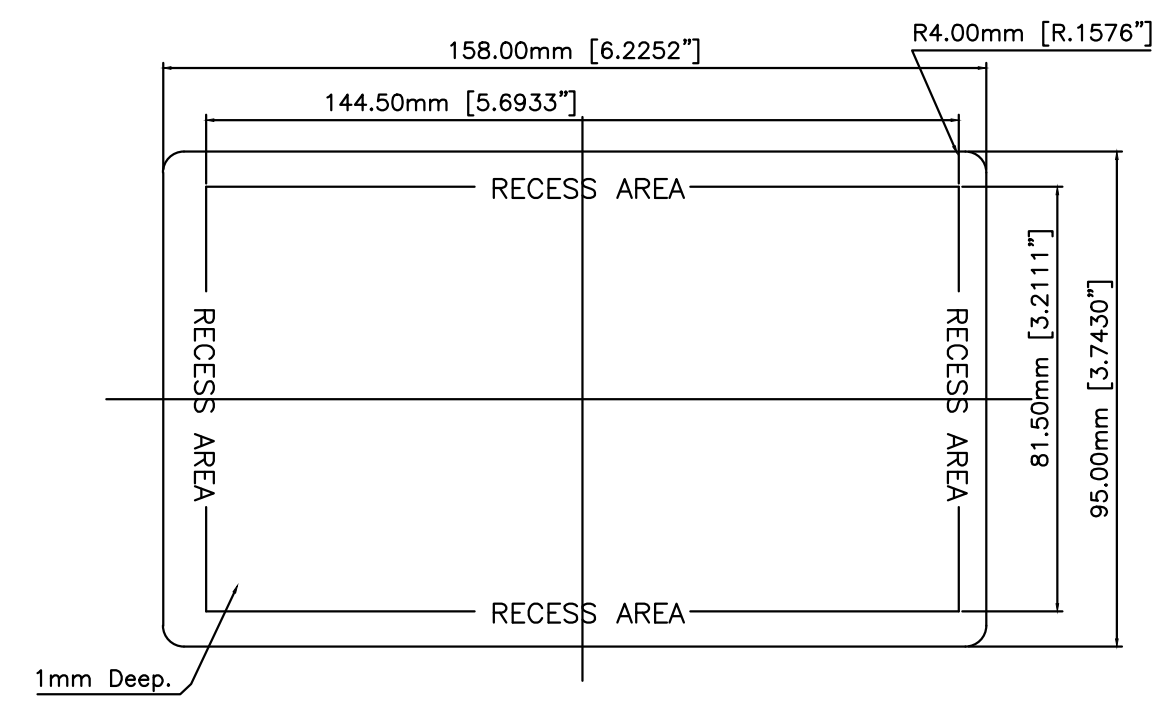

TOP-OUTSIDE

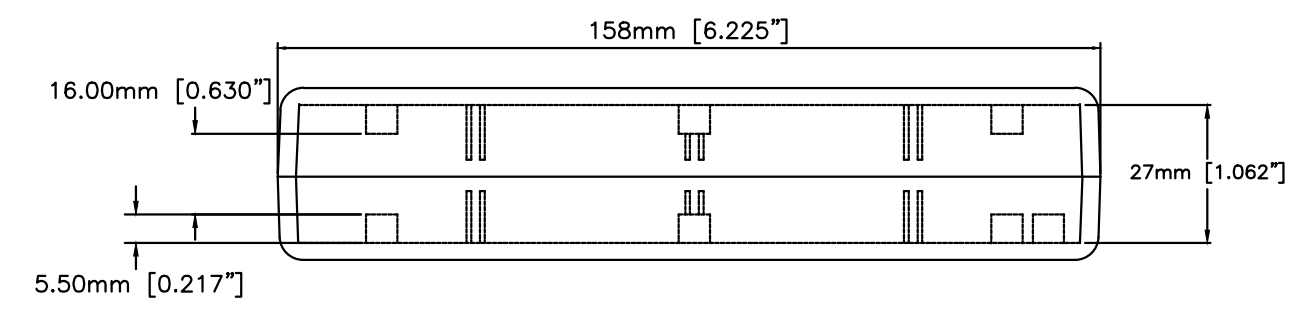

SIDE VIEW

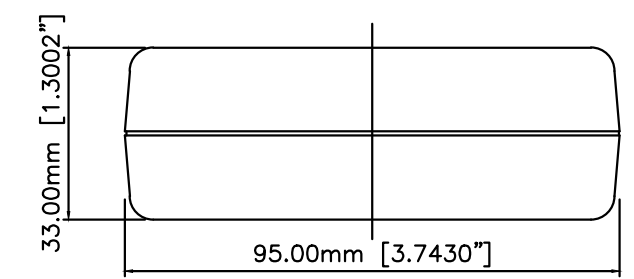

END VIEW



Title Eng. Drawing C size Master		
DATE 3/9/19	BOX # UCCL-131-MASTER	Drn. by R.F.K.
SCALE 1:1	SHEET 1 of 1	REV 19.A

THIS DRAWING IS THE PROPERTY OF AND MAY EMBODY PROPRIETARY INFORMATION OWNED BY Box Enclosures® IT IS PROVIDED UNDER A CONFIDENTIAL RELATIONSHIP FOR A SPECIFIC PURPOSE. THE RECIPIENT AGREES TO USE IT ONLY FOR SUCH PURPOSE AND RETURN IT TO Box Enclosures® UPON REQUEST.