

SECTION B-B

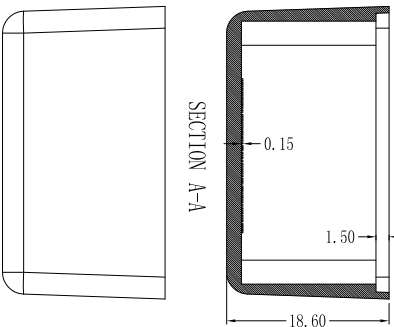

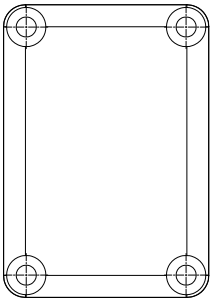

SECTION A-A

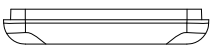
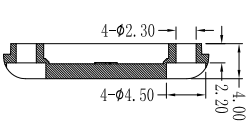
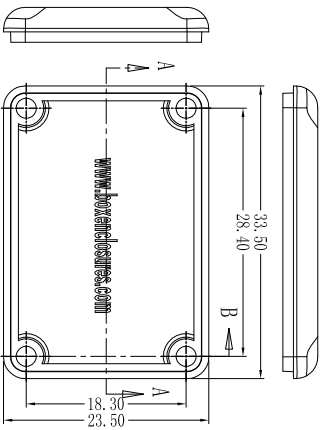
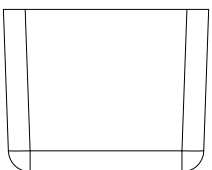
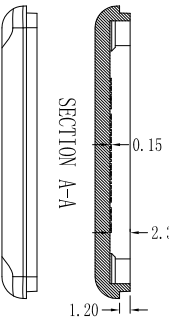
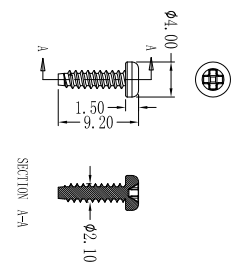

SECTION A-A

THIS DRAWING IS THE PROPERTY OF AND MAY BEHOLD PROPRIETARY INFORMATION OWNED BY BOX ENCLOSURES. IT IS PROVIDED UNDER A CONFIDENTIAL RELATIONSHIP FOR A SPECIFIC PURPOSE. THE RECIPIENT AGREES TO USE IT ONLY FOR SUCH PURPOSE AND RETURN IT TO BOX ENCLOSURES UPON REQUEST.

 <p>ENCLOSURES & ASSEMBLY SERVICES</p>		Revision:	
		Model:	
Title BMC-205D Master Drawing		Dwg. No.:	Part No.:
Material: ABS	TOLERANCE all dimension in mm unless otherwise specified	Color:	Dwn. Date 18/1/2010 HJA
Finish:	x ±0.20 xx ±0.10 xxx ±0.05 ANGLE ±0.5°	Qty:	Chk. Date
Proj. 		Sheet of	App. Date